

EXPERTS IN WEIGHING SINCE 1969

# NEXT GENERATION DIGITAL LOAD CELLS

- Patented capacitive technology
- High accuracy and high resolution
- Very robust, up to 1000% overload
- Sanitary installation, easy to clean
- Simple electrical installation - Plug & Play
- ISO 9001:2015, IECEx and ATEX certified
- Trusted in over 90 countries worldwide

**Eilersen**  
The Weighing Experts



Weighing solutions for beverage processing



Load cells for mobile hygienic vessels



Load cells for pharmaceutical API manufacturing

# EXPERTS IN WEIGHING SINCE 1969

## Capacitive Digital Load Cells

Since the foundation in 1969, the Eilersen companies in Denmark and Switzerland have been dedicated to the development, manufacture and supply of high quality, robust industrial sensors based on capacitive technology for the measurement of force and weight.

### Patented Technology with Unique Advantages

This extensive know-how is patented worldwide and applied in the current range of digital load cells. The capacitive technology developed by Eilersen features a number of advantages compared to other technologies used in transducers for measuring force and weight, such as high accuracy (up to 99.99%), outstanding reliability, simple mechanical and electrical installation, and minimal maintenance for use in tough and demanding industrial applications.

Eilersen load cells are produced in stainless steel and hermetically sealed to IP68 by laser welding. Furthermore, Eilersen load cells are available in capacities up to 500 tons with a broad range of instrumentation including weighing

indicators and weighing modules featuring EtherNet IP, Modbus TCP/IP, PROFINET, Profibus DP, EtherCAT, RS485, 4-20mA and 0-10VDC interfaces. The Eilersen weighing solutions can be supplied in OIML, ATEX and IECEx certified versions.

All Eilersen products are developed, manufactured and individually calibrated at the Eilersen ISO 9001:2015 certified manufacturing facilities.

### Eilersen Load Cells are Trusted Worldwide

Eilersen customers include leading companies in more than 90 countries worldwide, and the continuous investment in technology, development, quality, and customer support has led to a very high level of customer loyalty.

The Eilersen companies have a sound financial basis and exercises environmental and social responsibility. Furthermore, Eilersen offers equal opportunity and non-discrimination policies, and benefits from a very stable team of dedicated employees.



Patents



OIML Certificates



IECEx/ATEX Certificates



ISO 9001:2015 Certificate



Material Certificates



NTEP

## WHO WE ARE



**90+**  
countries

Eilersen capacitive load cells are used by industrial customers in more than 90 countries. Our digital technology offers simple installation and integrated diagnostics while eliminating the need for maintenance.



**50+**  
years of experience

Since the foundation in 1969, we have been dedicated to the development, manufacture and supply of high quality, robust industrial sensors for the measurement of force and weight to industrial customers worldwide.



**15+**  
years of average tenure

We benefit from a very passionate and experienced team of employees, who on average have more than 15 years of tenure. The development of new products is based on all the know-how of our in-house team of engineers.



**10+**  
worldwide patents

Our extensive know-how is covered by several patents worldwide and applied in the current range of digital capacitive load cells. We were granted our first worldwide patent on capacitive load cells back in 1971.



**11+**  
nationalities

We have dedicated employees from more than eleven different nations, and with our focus on CSR, our production facilities have been awarded top score in the yearly reviews by the Work Environment Authorities.



**1**  
family

N. Juul Eilersen founded Eilersen Electric A/S in 1969 for the development, production and sales of capacitive sensors. We will remain family-owned, as the next generation has now taken over ownership.

## WHAT WE DO



**1500+**  
projects every year

Every year our digital weighing solutions are used by industrial customers in more than 1500 projects across many industries including pharmaceutical, food, logistics, automation, chemical, biotech and offshore.



**10+ %**  
R&D investment

We invest more than 10% of our annual turnover in research and development in order to continuously bring better load cells to the market and retain our position as The Weighing Experts.



**99.99 %**  
accuracy

Our reliable load cells offer up to 1000 % overload and up to 99.99 % accuracy, which makes life easier for our customers. With capacities up to 500 tons, our load cells cover most industrial applications.



**100 %**  
high quality

Eilersen delivers a consistent, high level of quality, with all products being assembled, tested and calibrated in-house. We hold ISO9001:2015, OIML, ATEX, IECEx and other certifications.



**4.8**  
on customer satisfaction

We asked more than 300 customers in 20 countries how they would rate our products and service on 15 different parameters on a scale from 1 to 5. The result was outstanding with an average rating of 4.8.



**3300+**  
customers worldwide

An ever increasing number of world class machine builders and end users from industries such as pharma, food, biotech, logistics and offshore rely on Eilersen capacitive load cells and weighing instrumentation.

# SELECTED REFERENCES



# HYGIENIC LOAD CELLS

High Accuracy and Reliability



# DIGITAL CAPACITIVE TECHNOLOGY

## The Choice for Industrial Applications

The Eilersen digital capacitive technology is based on a non-contacting ceramic sensor mounted in a low stressed load cell body. As the load cell contains no moving parts and the ceramic sensor is not in contact with the load cell body, the load cell tolerates very high overloads, sideloads, torsion and welding voltages.

### **Simple and Hygienic Installation**

This robust technology allows for a very simple and hygienic mechanical installation of the Eilersen load cells without expensive and complicated mounting kits, stay rods or overload protection devices. The simple installation eliminates the need for maintenance and reduces the total cost of ownership.

### **The True Digital Weighing Solution**

The electrical installation of the Eilersen digital load cells is pure plug-and-play as the output from the ceramic sensor is directly converted, compensated and calibrated by a proprietary ASIC in the load cell.

The output from the load cell contains the measuring data and status codes for diagnostics, which is transmitted through the load cell cable to the weighing instrumentation.

This patented digital technology eliminates drift and inaccuracy found in analog circuits, since the complete measurement chain is digital.

### **Individually Calibrated for High Accuracy**

Every Eilersen load cell is individually factory calibrated and compensated to ensure the highest accuracy (up to OIML C6 MI10 or 99.99%) and quality on the market.

### **Flexible Connectivity**

The Eilersen proprietary design results in unsurpassed flexibility, fast communication and allows for connection to a wide range of equipment, fieldbus interfaces and outputs (PLCs, PCs, SCADA systems, Weighing Terminals, PROFINET, EtherCAT, EtherNet/IP, Modbus TCP/IP, RS485, 4-20mA, 0-10VDC etc.).

### **Easy Commissioning and Service**

The pre-calibration of the Eilersen load cells and the possibility to monitor the load and status of each individual digital load cell, provides visibility, easy troubleshooting and saves time during commissioning.

Furthermore, the load cell cables can be replaced on-site if required, and the cable length (up to 100 meters) has no influence on the load cell calibration.

### **Patented and Trusted Worldwide**

The capacitive technology and mechanical design applied in the Eilersen load cells is patented, and trusted by customers in more than 90 countries worldwide.



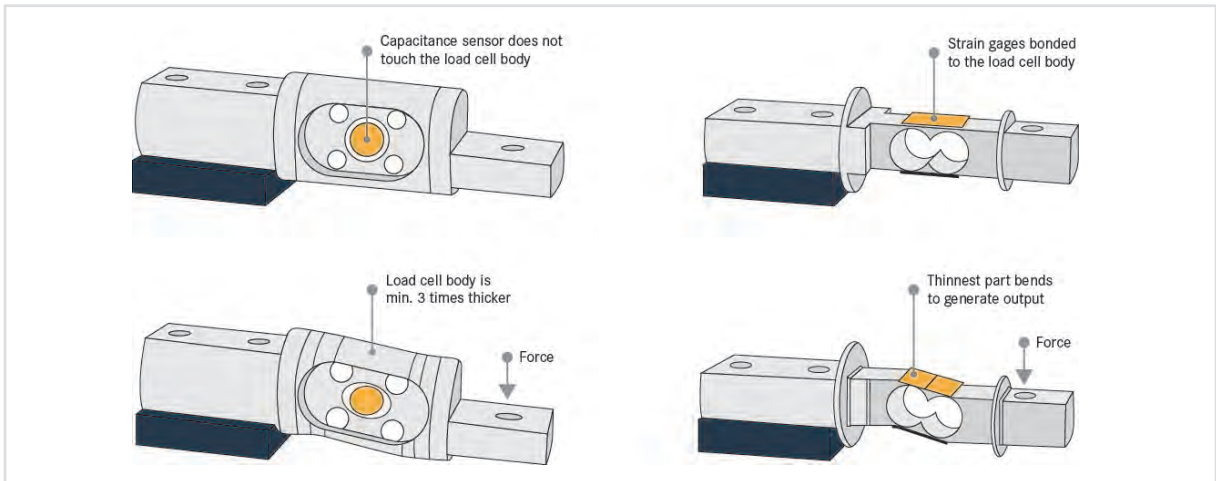

The Eilersen digital capacitive technology is based on an accurate and stable ceramic sensor, which is non-contacting and therefore unaffected by overloads, sideloads, torsion and welding voltages.



# DIGITAL TECHNOLOGY

## Intelligent setup ensures correct and quick commissioning

Our new intelligent setup feature automatically makes suggestions for the configuration of the various technical weighing parameters to help ensure an accurate and fast installation of the weighing system. You can use this feature during both the installation and commissioning of the weighing system.

The intelligent setup eliminates time-consuming installation instructions, manuals, and descriptions for standard applications. This again reduces both time spent and the risk of errors in the configuration of the weighing system.

The Eilersen digital weighing terminals will also provide suggestions and information for the following:

- Performance optimization through integrated filter options
- Stability limit and zero tracking
- System and corner calibration
- Linearization points
- Diagnostics and serial no. for all connected load cells.



# UNIQUE BENEFITS

FEATURE	ADVANTAGES	BENEFITS
Hygienic/ sanitary design and installation	<ul style="list-style-type: none"> <li>• easy to clean</li> <li>• no need for expensive mounting kits</li> <li>• high cleanliness in production</li> <li>• less time/cost for cleaning</li> </ul>	<ul style="list-style-type: none"> <li>• high product quality</li> <li>• minimizes the risk of product recalls</li> <li>• reduces risk of contamination</li> <li>• increased production up-time</li> <li>• lower total cost of ownership</li> </ul>
Capacitive technology	<ul style="list-style-type: none"> <li>• robustness</li> <li>• up to 10 times overload</li> <li>• load cell tolerates welding on installation</li> <li>• insensitive to EMC</li> <li>• no moving parts</li> </ul>	<ul style="list-style-type: none"> <li>• reliability</li> <li>• install and forget/worry-free installation</li> <li>• maintenance-free</li> <li>• faster installation and commissioning</li> <li>• saves time and money</li> </ul>
True digital technology	<ul style="list-style-type: none"> <li>• digital measuring chain</li> <li>• no error from amplifiers</li> <li>• pre-calibrated</li> <li>• field-replaceable cables</li> <li>• up to 100m load cell cables length</li> <li>• single wire coaxial cable (no 6 wire cables)</li> <li>• no need for a junction box</li> <li>• no need to balance weight distribution on load cells (e.g., tanks)</li> <li>• plug-and-play</li> </ul>	<ul style="list-style-type: none"> <li>• mimimizes need for on-site calibration</li> <li>• easy integration to factory automation</li> <li>• faster installation and commissioning</li> <li>• ready for industry 4.0</li> <li>• fewer components that can fail</li> </ul>
Fieldbus communication	<ul style="list-style-type: none"> <li>• easy to upgrade from analog to digital interface</li> <li>• modular concept</li> <li>• cover all common Fieldbus standards</li> </ul>	<ul style="list-style-type: none"> <li>• easy integration to factory automation</li> <li>• future proof</li> <li>• enables individual reading of load cell values and diagnostics</li> </ul>
Small deflection	<ul style="list-style-type: none"> <li>• faster response rate for dynamic weighing</li> <li>• less influence from process piping</li> </ul>	<ul style="list-style-type: none"> <li>• higher accuracy in practice for process weighing</li> <li>• minimizes need for on-site calibration</li> </ul>

# TOP 10 REASONS

## For Choosing Eilersen Weighing Solutions

### #1

#### Robust and Reliable Load Cells

All Eilersen load cells tolerate very high overloads, sideloads and torsion. The load cells are produced in stainless steel and hermetically sealed to IP68 for tough industrial applications. Furthermore, Eilersen load cells are available in capacities up to 500 tons.

### #2

#### Simple Mechanical Installation

Mechanical protection devices are not necessary when installing Eilersen digital load cells. This is not only an important cost and maintenance saver, but also allows for a hygienic installation.

### #3

#### Simple Electrical Installation

Eilersen digital load cells feature true plug-and-play installation as the load cells are pre-calibrated, which eliminates the need for on-site calibration in many applications.

Eilersen digital load cells can be equipped with up to a 100 meter load cell cable and the cable length has no influence on the load cell calibration.

### #4

#### Minimized on-site Installation Cost for OEM Customers

The very high overload tolerance of Eilersen load cells allows for in-factory installation of the load cells in OEM equipment, which eliminates the need for expensive and complicated transport brackets.

### #5

#### Easy Commissioning and Service

It is possible to monitor the load and status of each individual Eilersen load cell with the integrated load cell diagnostics feature.

Eilersen digital load cells do not require regular maintenance but if maintenance is required, the integrated system will alert users, providing fast and easy troubleshooting.

### #6

#### Ideal Load Cells for Dynamic Applications

Eilersen digital load cells feature sampling rates of up to 1000 measurements per second and a deflection of less than 0.1 mm at Full Scale (FS) which results in a high frequency of resonance.

### #7

#### Top Specifications

Eilersen digital load cells can be supplied in OIML (up to C6 MI10), IECEx and ATEX certified (zone 1, 2, 21, 22) versions while still offering a very high overload tolerance.

### #8

#### Flexible Solutions

Eilersen weighing modules are available with a range of fieldbus interfaces (Profibus DP, PROFINET, EtherCAT, Ethernet IP, Modbus TCP/IP, 4-20mA, 0-10VDC etc.).

### #9

#### ISO 9001:2015 Certified Quality

All Eilersen load cells are developed, manufactured and individually calibrated at the Eilersen ISO 9001:2015 certified sites in Denmark and Switzerland to ensure that all products meet the highest quality standards on the market.

### #10

#### Patented and Trusted Worldwide

The capacitive technology and mechanical design of the Eilersen load cells has been patented and is trusted by customers in more than 90 countries worldwide.



Load cells for mixing



Load cells for mining in Greenland



BL load cell mounted under hopper

**Eilersen**  
The Weighing Experts



Heavy duty weighing



Load cells for vegetable dosing

# RELIABLE WEIGHING

The Eilersen digital capacitive technology is based on a non-contacting ceramic sensor mounted inside the load cell body. Because the load cell contains no moving parts and the ceramic sensor is not in contact with the load cell body, the load cell tolerates very high overloads, sideloads, torsion, and is protected from stray welding voltages.

The load cell calibration data is stored inside the load cell, and a built-in temperature measurement circuit enables active temperature compensation.

This robust technology allows for a straightforward and hygienic mechanical installation of the Eilersen load cells without expensive and complicated mounting kits, stay rods, or overload protection devices. The simple installation eliminates the need for maintenance and reduces the total cost of ownership.



The Eilersen load cells used are characterized not only by their hygienic design but also by their high resolution and accuracy. Despite the vibrations from the agitator and pumps, the digital filter function of the Eilersen interface module guarantees the high accuracy of the weight measurement.

**Tim Füllmich**  
Responsible Project Manager at FTS

# EILERSEN

# ADVANTAGES

Compared to conventional strain gage technology – or other technologies used in transducers for measuring force and weight – Eilersen load cells offer significant benefits, especially in applications that experience overload, torsion or sideloads such as those found in mobile tanks and vessels.

#### **Minimal deflection**

A minimal deflection characterizes Eilersen load cells at rated capacity (less than 0.10 mm), a significant advantage in, e.g., dynamic weighing applications where a fast response is essential or process vessel installations where influence from process piping is minimized.

#### **Exceptional precision and resolution**

The high sensitivity of the Eilersen load cells, is the basis for the high resolution of the Eilersen load cells.

#### **Load cells are supplied pre-calibrated**

A built-in memory stores the calibration of the load cell, and usually, no adjustment is required either at commissioning or in the unlikely event that you need to replace a load cell. The Eilersen load cells contain no moving parts and are not assembled with glue or bonding, which can age or become brittle at low temperatures. This guarantees maintenance-free use under the most challenging environmental conditions for long periods of time.

#### **Maintenance-free weighing system**

Field-wiring small connections in complex arrangements is a thing of the past. Our capacitive load cells are maintenance-free, as there are no mounting and protection devices to adjust and keep clean and no fuses, gaskets, bearings, etc., to change. Thanks to the intelligent measurement principle, a permanent self-check is possible with simple means. Eilersen digital load cells will send an error code for fast and easy troubleshooting if a cable is damaged.

#### **Extremely robust and reliable**

Eilersen load cells can handle significant overload, and sideload. Since the capacitive sensor does not contact the stainless steel body, it is not subject to overload or sideload forces. In addition, you do not need any mounting kits or external guide rods to protect the load cell from overloads.

#### **Unique hygienic design**

Installing Eilersen load cells will minimize potential entrapment areas and maximize ease of cleaning. All hygienic cells, including the CL, CM, DLC, DCM, BL, and HBL series, are designed according to EHEDG guidelines and electropolished before shipment.

#### **Fast commissioning**

Equipment manufacturers can ship their systems with Eilersen load cells installed with no lockout or protection kits. This enables rapid field commissioning without added expense.

# ROBUST CAPACITIVE LOAD CELLS

Tolerates up to 1000% Overload



Cleaning  
Calibration  
Maintenance

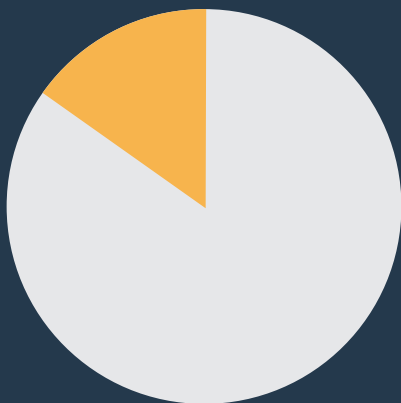

Productivity using  
strain gage Load Cells

HIGHER PRODUCTIVITY



Productivity using  
Eilersen Load Cells





Weighing meat tumblers



On-board weighing



**Eilersen**  
The Weighing Experts



Hygienic load cells installed under mixers



Eilersen supplies reliable weighing systems that fit well with our needs and applications. This makes the entire installation process and maintenance smooth and easy for us as customers. Eilersen provides good service and expert advice when new projects are being launched, so I'm sure Eilersen will remain our preferred supplier of weighing systems also in the future.

**Jan Juul**  
Production manager at CARLSBERG

## Product Overview

### Next Generation Digital Load Cells



### Digital Weighing Modules

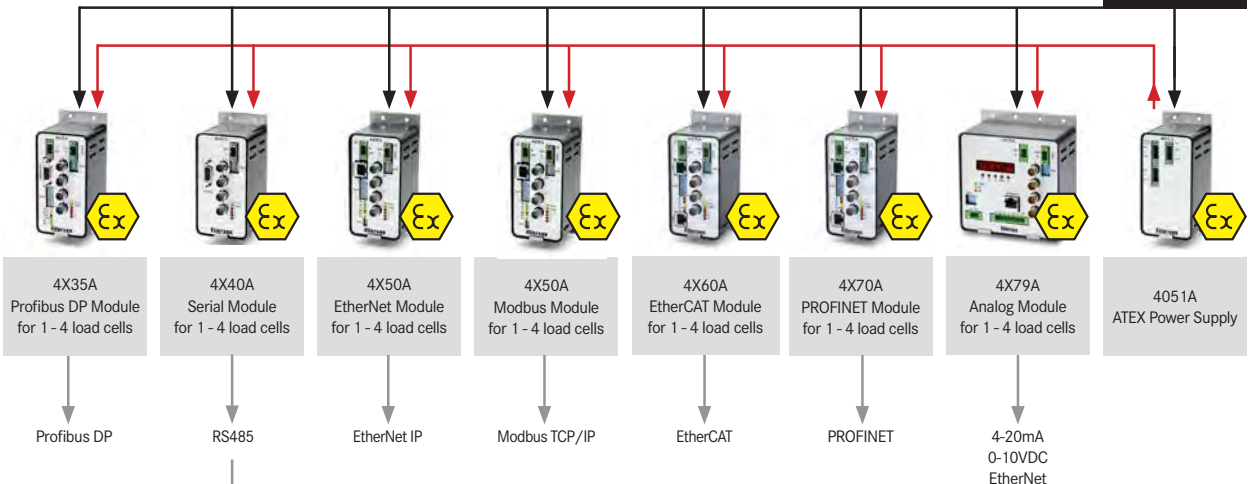
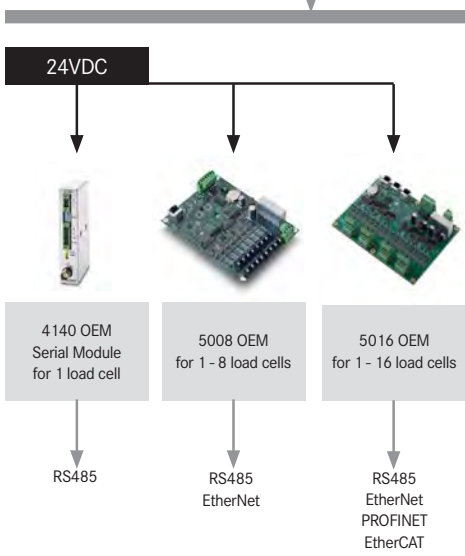

### Digital Weighing Indicator



Indicator LCD 5024G

## Load Cell Overview

Digital Capacitive Load Cells



NON-ATEX	BL	BM	XBL	SPSX	SPSXL	CL/CM	DLC/DMC	CH
ATEX	BL-Ex	BM-Ex	XBL-Ex	SPSX	SPSXL-Ex	CL/CM-Ex	DLC/DMC-Ex	CH-Ex
<b>Load Cell Type</b>								
Compression						■	■	■
Bending Beam	■	■						
Single Point			■	■	■			
<b>Load Cell Features</b>								
Digital Capacitive Technology	■	■	■	■	■	■	■	■
Stainless Steel	■	■	■	■	■	■	■	■
Hygienic Design	■	■				■	■	
IP68	■	■	■	■	■	■	■	■
Robust	■	■	■	■	■	■	■	■
<b>Specifications</b>								
Maximum Capacity (kg)	1000	7000	150	200	300	50000	20000	500000
Overload Tolerance	> 300% of Rated Capacity							
Interface Options	EtherNet IP, Modbus TCP/IP, PROFINET, Profibus DP, EtherCAT, RS485, 4-20mA, 0-10VDC							
<b>Applications</b>								
Process Weighing	■	■	■	■	■	■	■	■
Tank, Vessel & Silo	■	■				■	■	■
Filling & Dosing	■	■	■	■	■	■	■	
Level Measurement						■	■	■
Dynamic Weighing	■	■	■	■	■			
Scales	■	■	■	■	■			
Conveyer Belts	■	■	■	■				
Heavy Duty	■	■	■	■	■	■	■	■
On-Board Mobile Weighing		■						
Offshore Applications	■	■				■	■	■



MADE IN DENMARK - TRUSTED WORLDWIDE

# 50 Years of Digital Weighing Solutions

About 50 years ago, Mr. Nils Eilersen invented the capacitive weighing principle - and today, Eilersen is still the only company in the world to master this weighing technology.

The patented capacitive technology makes Eilersen the world leader in digital load cells, weighing instrumentation, and weighing solutions for industrial applications. A position the dedicated Eilersen team is constantly working to maintain and expand to new customers and industries.

That is why more than 15% of the turnover is invested directly into product development every year, with a department of experienced engineers assigned to this field.

Today, many of the largest and most recognized global companies within the food, pharmaceutical, chemical, logistics, and offshore industries in more than 90 countries worldwide benefit from the Eilersen weighing solutions.

## **Eilersen Electric Digital Systems A/S**

Kokkedal Industripark 4

DK-2980 Kokkedal

Denmark

Tel: +45 49 180 100

info@eilersen.com

Visit us at [www.eilersen.com](http://www.eilersen.com)

Rev. 1-2023

**Eilersen**  
The Weighing Experts