

The Flagship

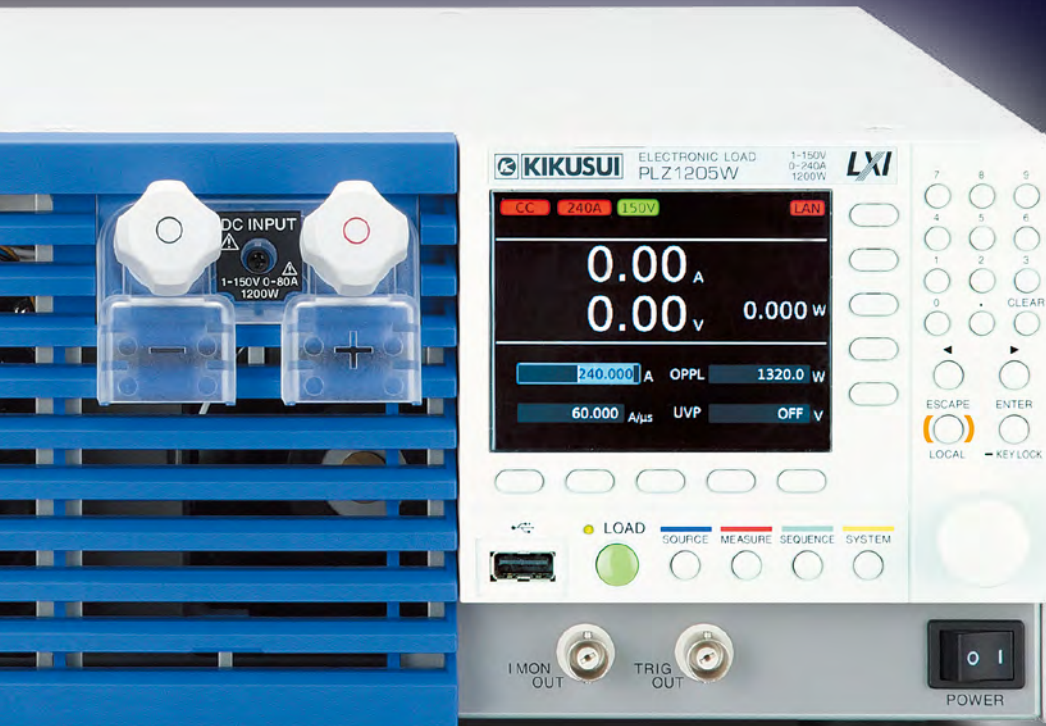

New

DC Electronic Load

Multifunctional Electronic Load PLZ-5W Series

Operation Voltage : 1 V to 150 V (from 0.05 V)

High Speed Slew Rate : 60 A/ μ s

Arbitrary I-V characteristics : Installed "ARB mode"

Parallel Operation Feature : The total current and power capacity can be increased to a maximum of 10.8 kW (2160 A) by connecting booster units.

New high visibility color display.

Various Communication Interfaces : LAN (LXI compliant), USB, RS232C, GPIB (Option), External Analog Control

Improved Sequence Feature (Maximum 10000 steps)

The New Flagship model is born!

Introducing the new standard of Electronic Load !

High-Speed Response, Advanced Communications, Large-Scale System Capability

The PLZ-5W Series high performance electronic load is the successor to the highly respected PLZ-4W series, whilst still retaining the same high specification and build quality.

Advances include a high visibility color display, low voltage operation from a minimum of 1 V to a maximum of 150 V. Programmable profiles of voltage/current can be applied (using the new ARB function, as used in LED/solar testing) in addition to the inherited 6 modes of operation: Constant Current, Constant Resistance, Constant Voltage, Constant Power, Constant Current + Constant Voltage, Constant Resistance + Constant Voltage.



Detachable input terminals for ease of use.

Equipped with a high-speed response feature boasting a maximum slew rate of 60 A/μs (PLZ1205W) and a minimum setting resolution of 10 μA (PLZ205W). Additional features of the PLZ-5W series include: Soft-start function, variable slew rate, selectable response (CV/CR mode), switching function, ABC preset memory, 20 user-defined set-up configurations, and a sequence operation function. The advanced high-speed response makes the PLZ-5W ideal for the development and testing of today's modern power supplies that require variable high-speed current changes. This advantage extends to the testing of current clamps/transducers.

The PLZ-5W Series is available in 4 standard models which can be incrementally extended by adding additional booster units (PLZ2405W) to achieve a maximum of 10.8 kW / 2160 A DC electronic load.

The following communication interfaces are installed as standard: LAN (LXI compliant), USB, RS232C and analog control. An optional GPIB interface is available.



Actual size

Applications	Research and development of Photo-Voltaic, (Hybrid) Electric vehicle drives, Fuel Cell technologies, Batteries, LEDs and Power Supplies.
--------------	--



PLZ1205W
PLZ2405WB

PLZ205W
PLZ1205W

DC ELECTRONIC LOAD **NEW**

Multifunctional Electronic Load PLZ-5W Series

Model	Operating voltage	Current	Power
PLZ205W	1 V to 150 V	40 A	200 W
PLZ405W		80 A	400 W
PLZ1205W		240 A	1200 W
PLZ2405WB		480 A	2400 W

[functions]

- Parallel Operation ●Communication function ●Current monitor output ●Variable slew rate ●Switching function ●Soft start function ●Elapsed time display and auto load off timer ●Remote sensing function ●Load on/off operations ●Range control input ●Trigger input ●Alarm input ●Alarm status output ●Load-on status signal output ●Range status output ●Short-circuit function ●External voltage control input(CC, CR, CV and CP modes) ●Overvoltage protection (OVP) ●Overcurrent protection (OCP) ●Overpower protection (OPP) ●Overheat protection (OTP) ●Undervoltage protection (UVP) ●Reverse connection detection (REV)

Color liquid crystal display (LCD)

High visibility color display. The voltage, current, power, current capacity (Ah) and power capacity (Wh) values are conveniently displayed.



New numeric keypad for ease of operation.

Direct input is now made possible.

Maximum Slew Rate of 60 A/μs

Achieving a rise time of 4 μs to reach the rated current of the electronic load. Power supply evaluation demands a fast transient response which the PLZ-5W series achieves with ease.

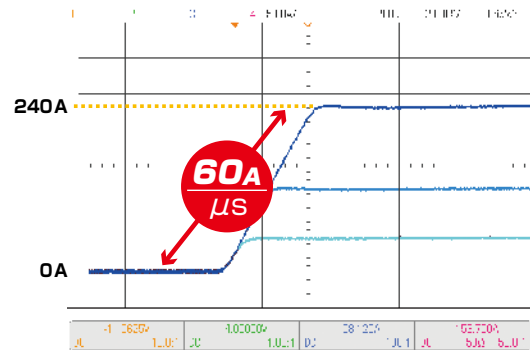

High speed voltage tracking characteristics

High speed voltage tracking characteristic in CR mode is perfect for applications such as startup tests for power supplies.

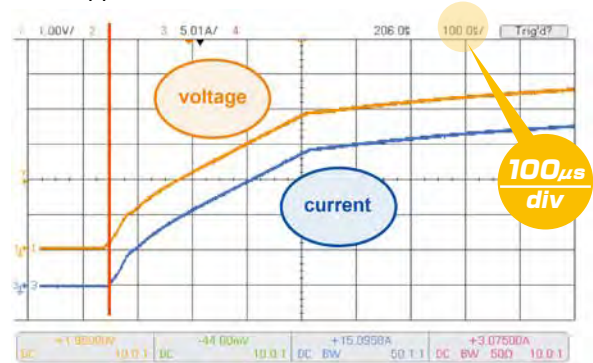

Communication interfaces are included as standard

LAN (LXI) / USB / RS232C as standard interface *GPIB Option



Rear Panels

Use a browser from a PC, smartphone, or tablet to access the web server built into the PLZ-5W series for convenient control and monitoring.

[Recommended browser]

- Internet Explorer version 9.0 or later
- Firefox 8.0 or later
- Safari/Mobile Safari 5.1 or later
- Chrome 15.0 or later
- Opera 11.0 or later

*Connecting with a smartphone, tablet, etc. requires a Wi-Fi environment (wireless LAN router etc.).

Application software

Sequence Creation Software SD023-PLZ-5W

The SD023-PLZ-5W (Wavy for PLZ-5W) is an application software that supports sequence creation and the operation of the Kikusui power supplies and the electronic load. The "Wavy" software allows you to create and edit sequences visually using a mouse without programming knowledge. It enables you to control the electronic load for monitoring the voltage and current, logging and so on.

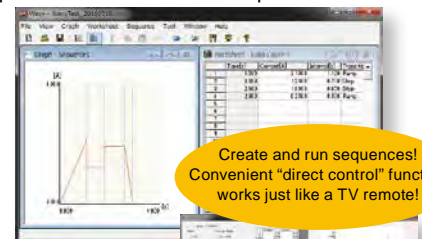

Sequence Creation / Execution Screen

Create and run sequences! Convenient "direct control" function works just like a TV remote!



Direct Control Screen

[See P9]

*For details, please see our company's homepage.



LXI compliant!!
control and monitor the power from built-in browser!

Operation modes

The following five operation modes are available on the PLZ-5W. These can be selected when the load is in the off state.

Constant current (CC) mode	A current value is specified and the current is kept constant even when the voltage changes.
Constant resistance (CR) mode	A conductance value is specified and the PLZ-5W sinks current proportional to the voltage variation.
Constant voltage (CV) mode	A voltage is specified and the PLZ-5W sinks current so that the voltage at the load input end of the PLZ-5W is constant.
Constant power (CP) mode	A voltage is specified and the PLZ-5W sinks current so that the power consumed inside the electronic load is constant.
Arbitrary I-V characteristics (ARB) mode	The desired load characteristics can be set by specifying multiple arbitrary voltage values and current values as I-V characteristics.

Adjustable slew rate

The speed of change can be set when the current is changed. The slew rate setting will function in the following instances.

- When the setting is changed to vary the current value (including the switching function).
- When the current value is changed using external control in constant current (CC) mode.
- When the current value is changed while the load is on.

CC Mode / High range / 0-80A Switching

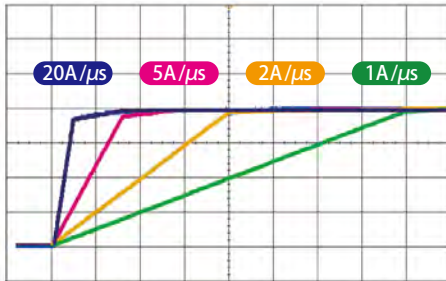

Ch4 load current 20A/div Horizontal 10μs/div

▲ Shift in the current waveform with the change in the slew rate

The slew rate is set according to the current range as an amount of current change per unit of time. Moreover, a common value is set for the rise and fall speeds. In CC mode and ARB mode, the slew rate can be set regardless of whether the load is on or off.

High precision and high resolution

The built-in three-range configuration provides wide dynamic range and high precision.

● PLZ205W operating range and setting resolution

		Operating range	Setting resolution
Constant current mode	H range	0 A to 40 A	1 mA
	M range	0 A to 4 A	0.1 mA
	L range	0 A to 0.4 A	0.01 mA
Constant resistance mode*	H range	40 S to 0.002 S	1 mS
	M range	4 S to 0.0002 S	0.1 mS
	L range	400 mS to 0.02 mS	0.01 mS
Constant voltage mode	H range	1 V to 150 V	5 mV
	L range	1 V to 15 V	0.5 mV
Constant power mode	H range	20 W to 200 W	0.005 W
	M range	2 W to 20 W	0.0005 W
	L range	0.2 W to 2 W	0.00005 W

* Conductance [S] = Input current [A] / Input voltage [V] = 1 / Resistance [Ω]

Load on/off operation

In addition to the regular operations, the following types of load on/off operations are available. You can choose any of these operations to suit for your operating environment.

- Start in the load on state
- Display of the elapsed load on time
- Auto load off after the elapse of the set time
- Load on/off control using relay and other external signals

Arbitrary I-V characteristics (ARB) mode

In ARB mode arbitrary I-V characteristics can be set by entering multiple I-V points (voltage and current value set points). From 3 to 100 points can be registered and the space between two points is automatically linearly interpolated. This mode can be used for simulation of LED loads and other DUT's with non-linear characteristics. [P7]

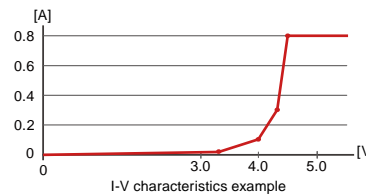

Example of settings

Voltage [V]	Current [A]
0	0
3.2	0.02
4.0	0.1
4.3	0.3
4.5	0.8
157.5	0.8

Short function

When the short function is activated, in constant current (CC) mode, the maximum current value, and in constant resistance (CR) mode, the minimum voltage value, is set, and the relay contact (30 Vdc/1 A) of the EXT CONT connector closes. The load input terminals can be shorted by driving an external high-current relay or the like.

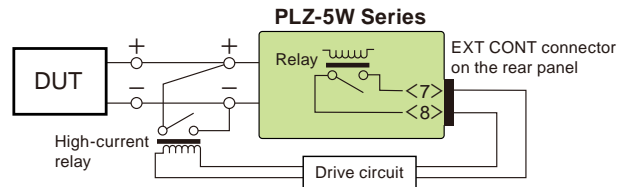

Switching function

In constant current and constant resistance modes, switching operations can be performed at up to 100 kHz. The switching setting parameters such as the switching level, switching frequency, and duty factor can be changed even while the load is on.

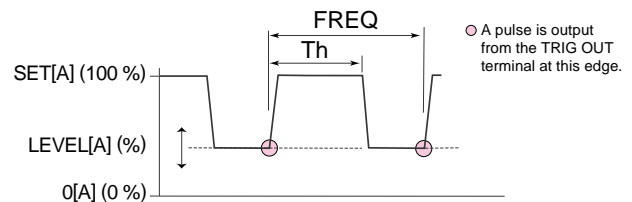

[Setting parameters]

■ Operation mode: CC and CR

■ Frequency setting range: 1 Hz to 100 kHz

■ Frequency setting resolution

1 Hz to 10 Hz	0.1 Hz
11 Hz to 100 Hz	1 Hz
110 Hz to 1 kHz	10 Hz
1.1 kHz to 10 kHz	0.1 kHz
10 kHz to 100 kHz	20 kHz, 50 kHz, 100 kHz

■ Frequency setting accuracy: ±(0.5 % of set)

■ Duty factor, steps

1 Hz to 10 Hz	
11 Hz to 100 Hz	5.0% to 95.0%, in steps of 0.1%
110 Hz to 1000 Hz	
1.1 kHz to 10.0 kHz	5.0% to 95.0%, in steps of 1%
10 kHz to 100 kHz	10% to 90%, in steps of 10%

* The minimum time interval for setting the duty factor is 5 μs.

Soft start function

Soft start is a function that controls the rise time of the load current. Soft start functions only when all the following conditions are met.

- The rise time of the soft start has been set.
- Load on state in constant current (CC) mode.
- There is an input that is equal to or exceeds the minimum operating condition, from the state where there is no input to the load input terminals.

This function is used if the output of the DUT becomes unstable when the load current rises sharply, or when wishing to delay only the current change at startup to prevent the overcurrent protection circuit of the power supply from getting activated.

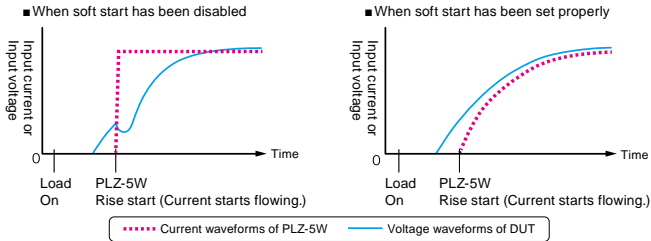

Can be set to OFF / 100 μs / 200 μs / 500 μs / 1 ms / 2 ms / 5 ms / 10 ms / 20 ms. This sets the soft start time.

Sequence function

Sequence is a function that executes a sequence of operations set in advance. A sequence consists of programs and steps. A program is a collection of steps. Steps are executed in order one at a time, starting from step 1. Upon completion of the last step of a program, execution of that program has been completed once.

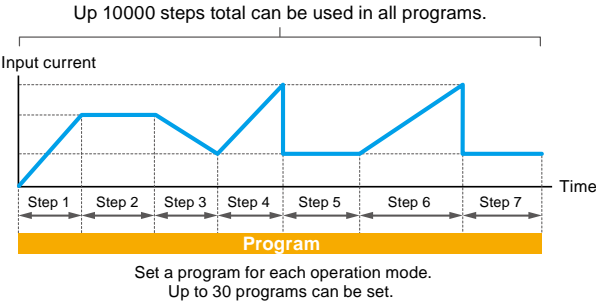

Setting item	Description
Load setting	Current, conductance, voltage, power. The values that can be set depend on the current operation mode.
Step execution time	0.000025s to 3600000s
Transition method of the current value	Step or Ramp
Number of loops of program	1 to 100000 repetitions, or infinite repetitions.
Sequence editing / execution / stop method	Front panel operation or remote operation via RS232C / LAN / USB.
Miscellaneous	Load on/off control, Slew Rate, CV mode addition, Trigger signal setting, trigger signal output, Specifies the value at which a protection function (OCP, OPP, UVP) is activated.

●TALink

Using the TALink (Transient Acquire Link)'s trigger, it can synchronize the step of the sequence and enables logging data to the PLZ5W. The logged data can be acquired through the communication with the PLZ5W.

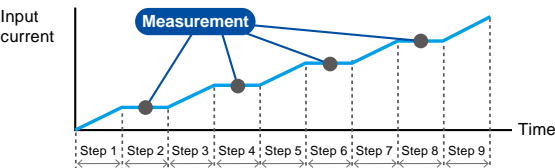

Remote sensing function

The voltage measurement point can be changed from the load input terminal to the DUT sensing point by executing remote sensing. By connecting the sensing leads at the DUT end, influences such as voltage drops caused by the resistance of the load cables can be reduced and the load current can be stabilized. To use remote sensing, connect the sensing cables to the sensing terminals of the PLZ-5W at the DUT end, and enable the remote sensing function.

- Possible remote sensing compensation voltage : approx. 7 V (Total potential difference between the input terminals and sensing terminals)

Auto load off timer

The auto load off timer automatically turns off the load after a specified time elapses from discharge start of the DUT. Measures the integrated power and the integrated current immediately after load off.

Applied to the discharge test of the battery.

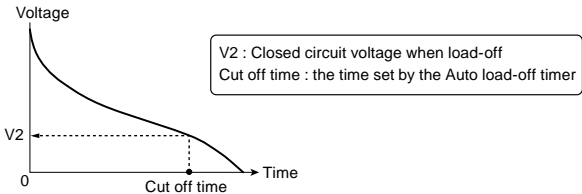

Synchronized operation

The following synchronization features can be used by simply connecting the PLZ-5W and other equipment to be synchronized with a communication cable.

- Turning the load on/off simultaneously for multiple equipment units.
 - Synchronizing measurements (remote control).
 - Synchronizing the sequence start timing and resume timing across multiple units.
- You can interconnect different PLZ-5W models (for example, PLZ205W and PLZ1205W). Synchronized operation is possible even during parallel operation.

Setup memory

The setup memory can store up to 20 sets (0 to 19) of the current conditions of the items listed below.

- Operation mode
- Load settings (current, conductance, voltage, power)
- Current range setting
- Voltage range setting
- Slew rate
- Switching level (current value/conductance value, or percentage)
- Switching interval (frequency/time of one cycle and duty cycle/operating time on the high side.)
- Alarm detection point
- Content of ABC preset memories

ABC Preset memories

Three memories A, B, and C are provided for each range in each mode, and the set values can be saved. The stored set values can be called freely even while the load is on and saved again. In constant current + constant voltage and constant resistance + constant voltage modes, the constant current and constant voltage memories and the constant resistance and constant voltage memories can be called and saved, respectively.

Diverse protection functions, Other functions

Overcurrent protection (OCP), Overpower protection (OPP), Overvoltage detection(OVP), Undervoltage protection (UVP), Overheat detection(OTP), Reverse-connection detection(REV), Alarm input detection, Configuration setting, Applied to the USB Keyboard.

Booster (PLZ2405WB)

*PLZ2405WB is a dedicated booster for PLZ1205W. It cannot be used with any other model.

Achieving 2400 W in "2U" size

Connecting up to 4 booster (PLZ2405WB) units with the master (PLZ1205W) increases the maximum system capability to 10.8 kW 2160 A. The optional parallel cable (PC01-PLZ-5W) is required to connect between the master and slave/booster units.

- Extended power with operable units of the booster. (maximum currents and maximum voltages)

Slave unit	1 unit	2 units	3 units	4 units
PLZ2405WB	720 A 3600 W	1200 A 6000 W	1680 A 8400 W	2160 A 10800 W



Booster unit PLZ2405WB



[Configuration example]



▲ 3.6 kW system combined with the PLZ1205W (upper unit) and PLZ2405WB (lower unit).

- Comparison with the existing system when connecting 4 booster units.

Comparison with the PLZ4W SR Series



- Large-capacity systems of 10.8 kW or more, rack-mounted systems, and other types of systems are supported. For more information, please contact our sales representatives.

External dimensions (max): 430(440)W×86(105)H×450(505)Dmm
Weight: Approx. 15 kg (33.07 lb)

Parallel operation

Multiple units of the same type can be connected in parallel.

Without using boosters, you can connect up to five units of the same model in parallel, including the master unit (max. 6 kW, 1200 A). In the parallel connection configuration, one control master operates with one or more slave units, enabling you to control the entire system and view the sum of the combined data on the master unit's panel. To connect the units requires the use of as many optional parallel cables (PC01-PLZ-5W) as the number of units to be connected.

*The PLZ2405WB (Booster) comes with 1 pc. of parallel operation cable (PC01-PLZ-5W).

- Number of parallel connected units and capacities (maximum currents and maximum voltages)

Slave unit	1 unit	2 units	3 units	4 units
PLZ205W	80 A 400 W	120 A 600 W	160 A 800 W	200 A 1000 W
PLZ405W	160 A 800 W	240 A 1200 W	320 A 1600 W	400 A 2000 W
PLZ1205W	480 A 2400 W	720 A 3600 W	960 A 4800 W	1200 A 6000 W

*Additional parallel operation calibration can achieve the same setting and measurement accuracy of a single unit.

● Connection example

Parallel operation using boosters (PLZ1205W only)

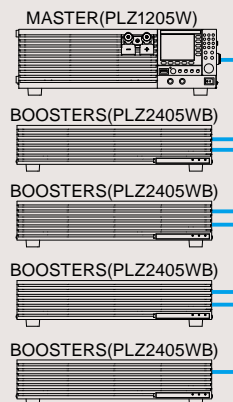

Parallel operation signal cable (PC01-PLZ-5W)

Parallel operation using the same type of electronic loads

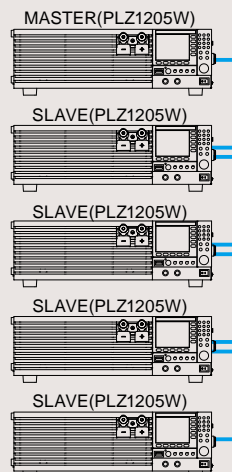

Evaluation of a broad range of current sensors.

Easily calibrate and evaluate current sensors by combining the PLZ-5W with a high-precision constant current DC power supply.

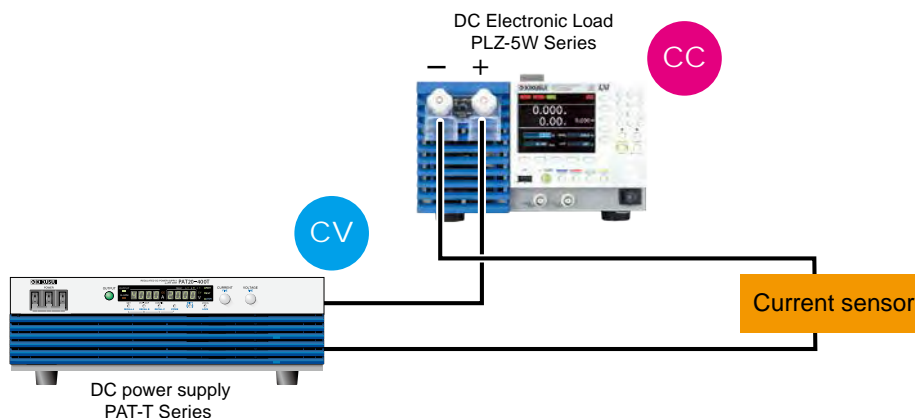

LED Load Simulation (Example)

● Arbitrary I-V characteristics (ARB) mode

In ARB mode arbitrary I-V characteristics can be set by entering multiple I-V points (voltage and current value set points). From 3 to 100 points can be registered, and the space between two points is automatically linearly interpolated. This mode can be used for simulation of LED loads and other DUT's with non-linear characteristics.

■ Lighting LED lamp.....24 V, 48 V, 150 V

■ Lazer Diode.....4 V, 35 V, 60 V

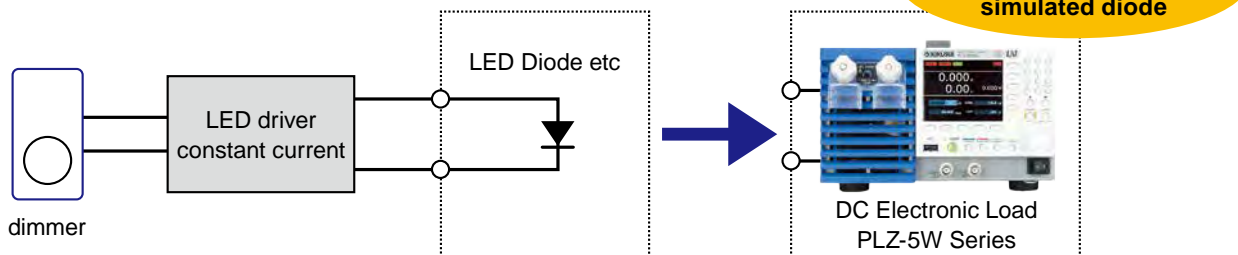

Impedance measurement of the power supply (Example)

Measure power supply impedance by configuring a system using the PLZ-5W, a function generator, and a digital multimeter.

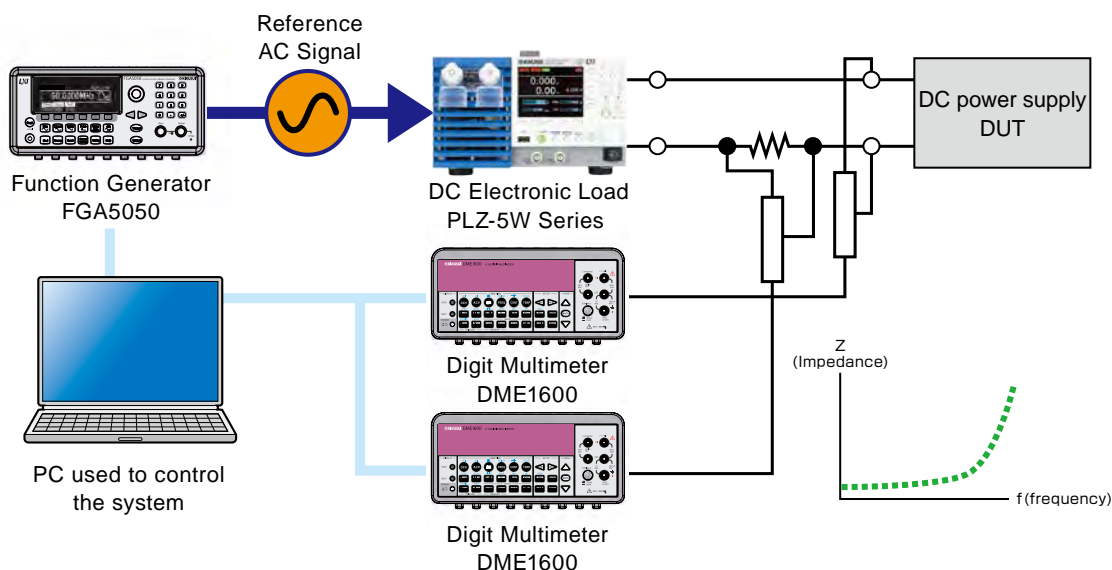

PLZ-5W SR Large scale system SR Series (Smart Rack)

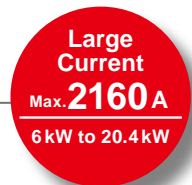

A compact, large scale system, SR (Smart Rack) Series is also available. The input power is available in 6 kW, 10.8 kW, 15.6 kW, and 20.4 kW. The maximum input current is 2160 A. (*1200 A for PLZ6005W)

- The system offers from 6 kW to 20.4 kW, in 4 models.
- Assembled with exclusive components based on optimization design concept.
- Delivered systems are fully assembled and tested, so immediate operation is possible.
- Smallest in class.
- AC Input 90 V to 250 V Auto select. No special wiring is required.
- Range switching function allows to guarantees the specification even for the smallest input. (Performance test Data is included with the system as standard document)
- LAN/USB/RS232C as standard interface. *GPIB option
- Capable of operation using the Sequence Creation software "Wavy".
- The Load input terminal is designed on the Safety-Comes-First concept. (protection against electric shocks)
- Load cable for large current is available.



PLZ6005W SR

PLZ10005W SR

PLZ15005W SR

PLZ20005W SR

6 kW

10.8 kW

15.6 kW

20.4 kW



Terminal Cover

Safety covers supplied on all models.

Maximizing safety with ease of access with a user friendly terminal cover design.

Applications (example)

- Charge/Discharge test on the large capacity secondary battery
- Converter evaluation
- Alternator evaluation
- FC stack cell evaluation
- PV panel evaluation
- EV charger evaluation
- Heat generation evaluation by the harness electric conduction
- Capacitor endurance test
- Evaluation on the industrial large capacity DC power supply system

PLZ-5W SR Series

Specifications	Rating			Constant current mode (CC)				Constant voltage mode (CV)			
	Operating voltage	Current	Power	Operating range			Ripple	Operating range		Resolution	
	V	A	W	H range (A)	M range (A)	L range (A)	mArms*	H range (V)	L range (V)	H range (mV)	L range (mV)
PLZ6005W SR	1 to 150	1200	6000	0 to 1260	0 to 126	0 to 12.6	120	0 to 157.50	0 to 15.750	5	0.5
PLZ10005W SR		2160	10800	0 to 2268	0 to 226.8	0 to 22.68	216				
PLZ15005W SR		15600	0 to 3276	0 to 327.6	0 to 32.76	312					
PLZ20005W SR		20400	0 to 4284	0 to 428.4	0 to 42.84	408					

Specifications	Constant resistance mode (CR)			Constant power mode (CP)			Weight	Power consumption
	Operating range			Operating range			Approx.	Approx.
	H range (S)	M range (S)	L range (S)	H range (W)	M range (W)	L range (W)	kg	VA
PLZ6005W SR	1260 to 0	126 to 0	12.6 to 0	0 to 6300	0 to 630	0 to 63.0	82	275
PLZ10005W SR	2268 to 0	226.8 to 0	22.68 to 0	0 to 11340	0 to 1134	0 to 113.4	120	465
PLZ15005W SR	3276 to 0	327.6 to 0	32.76 to 0	0 to 16380	0 to 1638	0 to 163.8	160	655
PLZ20005W SR	4284 to 0	428.4 to 0	42.84 to 0	0 to 21420	0 to 2142	0 to 214.2	200	855

* Measurement frequency bandwidth: 10 Hz to 1 MHz At measurement current of 100 A

High Current Load Wire (Solderless terminals on both ends.)

Model	DC14-2P3M-M12M8	DC38-2P3M-M12M8	DC80-2P3M-M12M8	DC80-2P3M-M12M12	DC150-2P3M-M12M12	DC150-4P3M-M12M12	DC600-2P3M-M12M12
Maximum Allowable voltage	650 V						150 V
Maximum Allowable current	50 A	100 A	200 A	200 A	300 A	500 A	1000 A
Terminal	M12 / M8	M12 / M8	M12 / M8	M12 / M12	M12 / M12	M12 / M12	M12 / M12
Nominal Cross-Sectional Area	14 mm ² (Equivalent of AWG5)	38 mm ² (Equivalent of AWG1)	80 mm ² (Equivalent of AWG3/0)	80 mm ² (Equivalent of AWG3/0)	150 mm ² (Equivalent of AWG6/0)	150 mm ² (Equivalent of AWG6/0)	600 mm ²
Length / Weight *Per cable	Approx. 3 m / Approx. 0.5 kg	Approx. 3 m / Approx. 1.4 kg	Approx. 3 m / Approx. 2.8 kg	Approx. 3 m / Approx. 2.8 kg	Approx. 3 m / Approx. 5 kg	Approx. 3 m / Approx. 5 kg	Approx. 3 m / Approx. 20 kg
Exterior design							

GPIB converter (PIA5100)

This converter converts RS232C or USB of the PLZ-5W to GPIB, enabling connection of a remote controller using GPIB.

[Accessories: Power cord set, Magnetic sheet]



[Connection example]

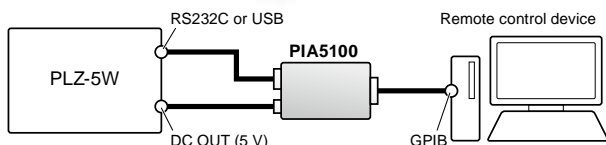

Parallel operation signal cable kit (PC01-PLZ-5W)

One cable required for each slave/booster unit.
Cable length : 30cm

*The PLZ2405WB (Booster) comes with 1 pc. of parallel operation cable (PC01-PLZ-5W).



Rack adapters, brackets

These are rack mounting options.

Rack adapter

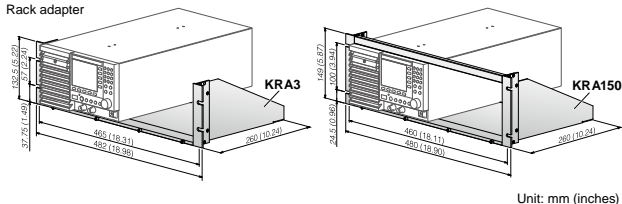

Bracket

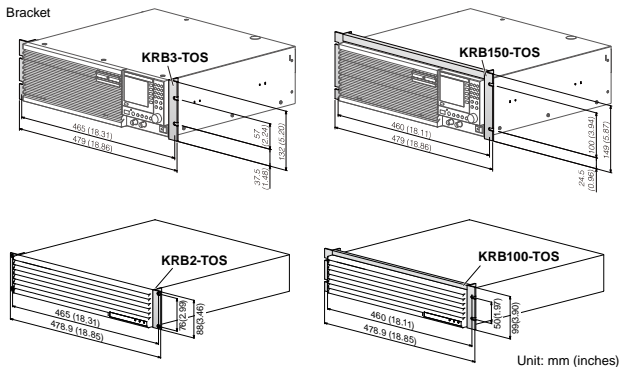

Name	Model	Appropriate Model	Description
Rack adapters *1	KRA3	PLZ205W	For EIA inch racks
	KRA150	PLZ405W	For JIS millimeter racks
Bracket	KRB3-TOS	PLZ1205W	For EIA inch racks
	KRB150-TOS		For JIS millimeter racks
	KRB2-TOS	PLZ2405WB	For EIA inch racks
	KRB100-TOS		For JIS millimeter racks

*1 When using blank panels for rack adapters, please use KBP3-2.

Application software

Sequence creation software

Wavy series



■ Sequence creation software

Wavy for the PLZ-5W (SD023-PLZ-5W)

[Operating environment] Windows 7 / Windows 8.1 / Windows 10

*For details, please refer to our web site.

The intuitive software allows the user to create complex current waveform and sequence profiles which will automatically populate the spread sheet with just the use of a mouse.

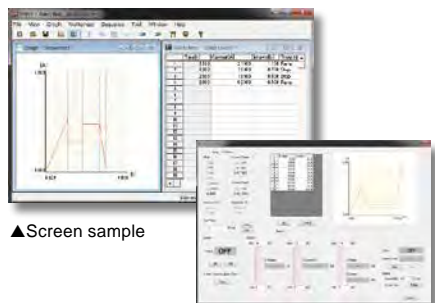

▲ Screen sample

- Creating and editing data of test conditions required so that the sequence operation can be done easily.
- Using the save function for data files of test conditions makes routine test condition control easy.
- The progress of executed sequences is displayed by the cursor and settings on an "execution graph."
- It is possible to observe actual output intuitively, using a "monitor graph" that plots monitored values while an execution is in progress.
- Acquired monitor data can be saved as test results.
- A "waveform image" window was newly added, making it easy to see the waveforms of alternating current (AC) signals.
- Arbitrary new waveforms can be easily created and edited. Also, arbitrary waveforms that are created can be quickly written and output.
- The product supports the selection and nonselection of sequence step items. Functions such as the pause function, trigger function, and AC waveform can be selected as needed.

Download !

Trial version is available on our web !!

<http://www.kikusui.co.jp/en/download/index.html>

PLZ205W/PLZ405W/PLZ1205W Specifications

Ratings			
Item	PLZ205W	PLZ405W	PLZ1205W
Operating voltage	1 V to 150 V *1		
Current	40 A	80 A	240 A *2
Power	200 W	400 W	1200 W
The minimum operating voltage	approximately 0.05 V. (At the load input terminals on the rear panel.)		
Input resistance when the load is off	Approx. 660 kΩ *3		
Load input terminal's isolation voltage	±500 V		

*1 In switching mode, for every slew rate setting of 1 A / μs, the minimum operating voltage (including the voltage drop due to the wiring inductance component) increases by approximately 150 mV for the PLZ205W, 125 mV for the PLZ405W, and 75 mV for the PLZ1205W.

*2 80 A for the load input terminals on the front panel.
The specifications of the PLZ-5W are for the load input terminals on the rear panel and the load input terminals on the front panel may not meet the specifications.

*3 In the case of parallel operation using the same models, approx. 660 / number of units kΩ.

Constant current (CC) mode				
Item	PLZ205W	PLZ405W	PLZ1205W	
Operating range	H range	0 A to 40 A	0 A to 80 A	0 A to 240 A
	M range	0 A to 4 A	0 A to 8 A	0 A to 24 A
	L range	0 A to 0.4 A	0 A to 0.8 A	0 A to 2.4 A
Setting range	H range	0 A to 4.2 A	0 A to 8.4 A	0 A to 25.2 A
	M range	0 A to 4.2 A	0 A to 8.4 A	0 A to 25.2 A
	L range	0 A to 0.42 A	0 A to 0.84 A	0 A to 2.52 A
Resolution	H range	1 mA	2 mA	5 mA
	M range	0.1 mA	0.2 mA	0.5 mA
	L range	0.01 mA	0.02 mA	0.05 mA
Setting accuracy	H range	± (0.2% of set + 0.1% of range)		
	M range	± (0.2% of set + 0.3% of range)		
	L range	± (0.2% of set + 1% of range)		
Parallel operation	H range	± (0.4% of set + 0.8% of range)		
	M range	± (0.4% of set + 0.8% of range)		
	L range	± (0.4% of set + 5% of range)		
Input line regulation *1	4 mA	8 mA	24 mA	
Ripple	rms *2	4 mA	8 mA	24 mA
	p-p *3	40 mA	80 mA	200 mA

*1 When the input voltage is changed from 1 V to 150 V at a current of rated power / 150 V.

*2 Measurement frequency bandwidth: 10 Hz to 1 MHz

*3 Measurement frequency bandwidth: 10 Hz to 20 MHz

Constant resistance (CR) mode				
Item	PLZ205W	PLZ405W	PLZ1205W	
Operating range *1	H range	40 S to 0.002 S (0.025 Ω to 500 Ω)	80 S to 0.004 S (0.0125 Ω to 250 Ω)	240 S to 0.012 S (0.0042 Ω to 83.333 Ω)
	M range	4 S to 0.0002 S (0.25 Ω to 5000 Ω)	8 S to 0.0004 S (0.125 Ω to 2500 Ω)	24 S to 0.0012 S (0.042 Ω to 833.33 Ω)
	L range	400 mS to 0.02 mS (2.5 Ω to 50000 Ω)	800 mS to 0.04 mS (1.25 Ω to 25000 Ω)	2 400 mS to 0.12 mS (0.42 Ω to 8333.3 Ω)
Setting range	H range	42 S to 0 S (0.0238 Ω to Open)	84 S to 0 S (0.0119 Ω to Open)	252 S to 0 S (0.00397 Ω to Open)
	M range	4.2 S to 0 S (0.238 Ω to Open)	8.4 S to 0 S (0.119 Ω to Open)	25.2 S to 0 S (0.0397 Ω to Open)
	L range	420 mS to 0 S (2.38 Ω to Open)	840 mS to 0 S (1.19 Ω to Open)	2520 mS to 0 S (0.397 Ω to Open)
Resolution	H range	1 mS	2 mS	5 mS
	M range	0.1 mS	0.2 mS	0.5 mS
	L range	0.01 mS	0.02 mS	0.05 mS
Setting accuracy *2	H range	± (0.5% of set + 0.5% of range)		
	M range	± (0.5% of set + 0.5% of range)		
	L range	± (0.5% of set + 1.5% of range)		
Parallel operation	H range	± (0.5% of set + 1.5% of range)		
	M range	± (0.5% of set + 1.5% of range)		
	L range	± (0.5% of set + 5% of range)		

*1 Conductance [S] = input current [A]/input voltage [V] = 1 / resistance [Ω]

*2 Converted value at the input current. At the sensing terminals.

Constant voltage (CV) mode			
Item	PLZ205W	PLZ405W	PLZ1205W
Operating range	H range	1 V to 150 V	
	L range	1 V to 15 V	
Setting range	H range	0 V to 157.5 V	
	L range	0 V to 15.75 V	
Resolution	H range	5 mV	
	L range	0.5 mV	
Setting accuracy *1	± (0.1% of set + 0.1% of range)		
	Parallel operation	± (0.2% of set + 0.2% of range)	
Input current variation *2	12 mV		

*1 With the input voltage within the operating range, and at the sensing terminals during remote sensing.

*2 For a current change in the range of 10% to 100% of the rating at an input voltage of 5 V (during remote sensing).

Constant power (CP) mode					
Item	PLZ205W	PLZ405W	PLZ1205W		
Operating range	H range	20 W to 200 W	40 W to 400 W	120 W to 1200 W	
	M range	2 W to 20 W	4 W to 40 W	12 W to 120 W	
	L range	0.2 W to 2 W	0.4 W to 4 W	1.2 W to 12 W	
Setting range	H range	0 W to 210 W	0 W to 420 W	0 W to 1260 W	
	M range	0 W to 21 W	0 W to 42 W	0 W to 126 W	
	L range	0 W to 2.1 W	0 W to 4.2 W	0 W to 12.6 W	
Resolution	H range	0.005 W	0.01 W	0.05 W	
	M range	0.0005 W	0.001 W	0.005 W	
	L range	0.00005 W	0.0001 W	0.0005 W	
Setting accuracy *1	H range	± (0.5% of range + 0.04 A × Vin)	± (0.5% of range + 0.08 A × Vin)	± (0.5% of range + 0.24 A × Vin)	
	M range	± (0.5% of range + 0.008 A × Vin)	± (0.5% of range + 0.016 A × Vin)	± (0.5% of range + 0.048 A × Vin)	
	L range	± (1% of range + 0.004 A × Vin)	± (1% of range + 0.008 A × Vin)	± (1% of range + 0.024 A × Vin)	
Parallel operation	H range	± (2% of range + 0.4% current range × Vin)			
	M range	± (2% of range + 0.4% current range × Vin)			
	L range	± (2% of range + 2.5% current range × Vin)			

*1 Vin: The voltage at the load input terminals on the rear panel or sensing terminals.

Arbitrary I-V characteristics (ARB) mode			
Item	PLZ205W	PLZ405W	PLZ1205W
Operating range	Three to 100 points of current values can be set for the input voltage. The space between two points is linearly interpolated.		
Response speed	Response for input voltage minimum 50 μs.		

Voltmeter			
Item	PLZ205W	PLZ405W	PLZ1205W
Display	H range	0.00 V to 150.00 V	
	L range	0.000 V to 15.000 V	
Accuracy	± (0.1% of reading + 0.1% of range)		
Parallel operation (TYP)	± (0.1% of reading + 0.1% of range)		

Ammeter				
Item	PLZ205W	PLZ405W	PLZ1205W	
Display	H range	0.000 A to 40.000 A	0.000 A to 80.000 A	0.00 A to 240.00 A
	M range	0.0000 A to 4.0000 A	0.0000 A to 8.0000 A	0.000 A to 24.000 A
	L range	0.00 mA to 400.00 mA	0.00 mA to 800.00 mA	0.0000 A to 2.4000 A
Accuracy	H, M range	± (0.2% of reading + 0.3% of range)		
	L range	± (0.2% of reading + 1% of range)		
Parallel operation (TYP)	H, M range	± (0.4% of reading + 0.8% of range)		
	L range	± (0.4% of reading + 5% of range)		

Power display			
Item	PLZ205W	PLZ405W	PLZ1205W
Display	Displays the product of the voltmeter reading and ammeter reading.		

Switching function			
Item	PLZ205W	PLZ405W	PLZ1205W
Operation mode	CC and CR		
Frequency setting range	1.0 Hz to 100.0 kHz		
Frequency setting resolution	1 Hz to 10 Hz.....0.1 Hz		
	11 Hz to 100 Hz.....1 Hz		
	110 Hz to 1000 Hz.....10 Hz		
	1.1 kHz to 10.0 kHz.....0.1 kHz		
	10 kHz to 100 kHz.....20 kHz, 50 kHz, 100 kHz		
Frequency setting accuracy	± (0.5% of set)		
Duty cycle setting range, step *1	1 Hz to 10 Hz.....5.0% to 95.0%, 0.1% steps		
	11 Hz to 100 Hz.....5.0% to 95.0%, 0.1% steps		
	110 Hz to 1000 Hz.....5.0% to 95.0%, 0.1% steps		
	1.1 kHz to 10.0 kHz.....5% to 95%, 1% steps		
	10 kHz to 100 kHz.....10% to 90%, 10% steps		

*1 The minimum time span is 5 μs. The minimum duty cycle is limited by the minimum time span.

Slew rate				
Item	PLZ205W	PLZ405W	PLZ1205W	
Operation mode				
CC				
Setting range	H range	0.01 A / μs to 10 A / μs	0.02 A / μs to 20 A / μs	0.06 A / μs to 60 A / μs
	M range	0.001 A / μs to 1 A / μs	0.002 A / μs to 2 A / μs	0.006 A / μs to 6 A / μs
	L range	0.1 mA / μs to 100 mA / μs	0.2 mA / μs to 200 mA / μs	0.6 mA / μs to 600 mA / μs
Resolution	H range	0.01 A / μs	0.02 A / μs	0.06 A / μs
	L range	0.001 A / μs	0.002 A / μs	0.006 A / μs
Setting accuracy *1	H, M range	± (10% of set + 1.25 μs)		
	L range	± (12% of set + 5 μs)		

*1 The time it takes to shift from 10% to 90% when the current is varied from 0% to 100% of the rated current.

Soft start			
Item	PLZ205W	PLZ405W	PLZ1205W
Operation mode			
CC			
Time setting range	100 μs, 200 μs, 500 μs, 1 ms, 2 ms, 5 ms, 10 ms, 20 ms, or off		
Time setting accuracy	± (30% of set + 10 μs)		

PLZ205W/PLZ405W/PLZ1205W Specifications

Possible remote sensing compensation voltage				
Item	PLZ205W	PLZ405W	PLZ1205W	
approx. 7 V (Total potential difference between the input terminals and sensing terminals)				
Protective function				
Item	PLZ205W	PLZ405W	PLZ1205W	
Overcurrent protection (OCP)	Setting range	0.0 A to 44.0 A	0.0 A to 88.0 A	0.0 A to 264.0 A
	Resolution	0.1 A	0.2 A	0.5 A
	Protection operation	Either load off or limitation can be selected.		
Overpower protection (OPP)	Setting range	0 W to 220 W	0 W to 440 W	0 W to 1 320 W
	Resolution	1 W	2 W	5 W
	Protection operation	Either load off or limitation can be selected.		
Undervoltage protection (UVP)	Setting range	0.00 V to 150.00 V, or off		
	Resolution	0.01 V		
	Protection operation	Load off		
Watchdog protection(WDP)	Setting range	60s to 3600s, or off		
	Protection operation	Load off		
EXT CONT connector				
Item	PLZ205W	PLZ405W	PLZ1205W	
Load on/off control input	Logic level switchable. Pulled up to 5 V by a 10 kΩ resistor. The thresholds are HIGH: 3.5 V to 5 V, LOW: 0 V to 1.5 V.			
Range control input	The range can be switched between L, M, and H using a 2 bit signal. Pulled up to 5 V by a 10 kΩ resistor. The thresholds are HIGH: 3.5 V to 5 V, LOW: 0 V to 1.5 V.			
Alarm input	An alarm is activated with a voltage between 0 V and 1.5 V. Pulled up to 5 V by a 10 kΩ resistor. The thresholds are HIGH: 3.5 V to 5 V, LOW: 0 V to 1.5 V.			
Alarm clearing input	After an alarm occurs, eliminate the root cause of the alarm, and change the input to pin 5 of the EXT CONT connector from a low level signal to a high level signal. The alarm will be cleared on the rising edge of this signal. Pulled up to 5 V by a 10 kΩ resistor. The thresholds are HIGH: 3.5 V to 5.0 V, LOW: 0 V to 1.5 V.			
Trigger input	Paused sequence operation resumes when a voltage between 0 V and 0.8 V is received. Pulled up to 5 V by a 10 kΩ resistor. The thresholds are HIGH: 2 V to 5 V, LOW: 0 V to 0.8 V.			
External voltage control input (CC, CR, CP mode)	Controls the load settings of CC, CR, CP mode through external voltage input. The input impedance is approx. 10 kΩ. CC: The setting can be controlled in the range of 0% to 100% of the rated current through external voltage input of 0 V to 10 V. CR: The setting can be controlled in the range of 0% to 100% of the conductance setting through external voltage input of 0 V to 10 V. CP: The setting can be controlled in the range of 0% to 100% of the rated power through external voltage input of 0 V to 10 V.			
	Setting accuracy	± (1% of range) (TYP value of H range in CC mode)		
External voltage control input (CV mode)	The load setting of CV mode can be controlled through external voltage input. The rated voltage can be controlled in the range of 0% to 100% with 0 V to 10 V. The input impedance is approx. 10 kΩ.			
	Setting accuracy	± (1% of range) (TYP value)		
External voltage control input (superimposing in CC mode)	Controls the load setting of CC mode by adding current through external voltage input. Adds current in the range of -100% to 100% of the rated current for -10 V to 10 V. The input impedance is approx. 10 kΩ.			
	Setting accuracy	± (1% of range) (TYP value of H range)		
Load-on status output	On when load is on. Open-collector output from a photocoupler.*1			
Range status output	Outputs current range state L, M, and H using 2 bits. Open-collector output from a photocoupler.*1			
ALARM 1 output	ON when overvoltage detection, reverse-connection detection, overheat detection, alarm input detection, front-panel load terminal overcurrent detection or parallel operation anomaly detection is activated. Open-collector output from a photocoupler.*1			
ALARM 2 output	On when OCP, OPP, UVP, or WDP is operating.			
DIGITAL 0 / DIGITAL 1 output	Logic signal output during a step of a sequence. Output impedance: approx. 330 Ω, output voltage: approx. 3.3 V _{EMF}			
DIGITAL 2 output	Can be switched between input and output. Output: Logic signal output during a step of a sequence. The output impedance is 330 Ω. Input: This signal is the trigger input signal for the sequence and the measurement functions. The thresholds are HIGH: 2 V to 5 V, LOW: 0 V to 0.8 V.			
	Current monitor output	Outputs 0 V to 10 V for 0% to 100% of the rated current of each range.		
Accuracy	± (1% of range) (TYP value of H range)			
Short signal output	Relay contact on when the short function is turned on (30 Vdc / 1 A).			
*1 The maximum voltage that can be applied to the photocoupler is 30 V. The maximum current is 4 mA.				
Front-panel BNC terminal				
Trigger output	Transmits 10 μs pulses when trigger output is ON during sequence operation and during step execution. Transmits 1 μs pulses during switching operation.			
Current monitor output	Outputs 0 V to 2 V for 0% to 100% of the rated current of each range.			
	Accuracy	± (1% of range) (TYP value of H range)		
Isolation voltage	±30 V			
Communication function				
LAN	IEEE 802.3 100Base-TX / 10Base-T Ethernet IPv4, RJ-45 connector			
RS232C	D-SUB 9-pin connector Baud rate: 9600, 19200, 38400, 115200 bps Data length: 8 bits, Stop bits: 1 bit, Parity bit: None, Flow control: None, CTS-RTS			
USB	Complies with the USB 2.0 specification. Data rate: 480 Mbps (High speed) Complies with the USB MC-USB488 device class specifications.			
General specifications				
Input voltage range / Input frequency range	100 Vac to 240 Vac (90 Vac to 250 Vac) single phase, continuous / 47 Hz to 63 Hz			
Power consumption	50 VA _{max}	50 VA _{max}	85 VA _{max}	
Inrush current (peak value)	45 A _{peak}			
Environmental conditions	Operating temperature range	0 °C to 40 °C (32 °F to 104°F)		
	Operating humidity range	20%rh to 85%rh (no condensation)		
	Storage temperature range	-20 °C to 70 °C (-4 °F to 158°F)		
	Storage humidity range	90%rh or less (no condensation)		
	Installation location	Indoor use, altitude of up to 2000 m, overvoltage category II.		
Insulation resistance	Between primary and input terminals	500 Vdc, 30 MΩ or more (70%rh or less)		
	Between primary and chassis			
	Between input terminals and chassis			
Withstanding voltage	Between primary and input terminals	No abnormalities at 1500 Vac for 1 minute.		
	Between primary and chassis	No abnormalities at 1500 Vac for 1 minute.		
	Between input terminals and chassis	No abnormalities at 750 Vac for 1 minute.		
Dimensions Unit: mm (inches)	214.5 (8.45)W×124 (4.88)H×400 (15.75)Dmm(inches)		429.5 (16.91)W×128 (5.04)H×400 (15.75)Dmm(inches)	
Weight	Approx. 7 kg (15.4 lb.)		Approx. 14 kg (30.9 lb.)	
Accessories	Power cord, Rear-panel load input terminal cover, Load input terminal screw set (2 sets), Screws for the rear-panel load input terminal cover (2 pcs.), Front-panel load input terminal cover, Front-panel load input knob set, External control connector kit, Setup Guide, CD-ROM, Quick Reference, Safety Information			
Electromagnetic compatibility (EMC) *1 *2	Complies with the requirements of the following directive and standards. EMC Directive 2014/30/EU, EN 61326-1 (Class A*3), EN 55011 (Class A*3, Group 1*4), EN 61000-3-2, EN 61000-3-3 Applicable under the following conditions. The maximum length of all cabling and wiring connected to the PLZ-5W must be less than 3 m.			
Safety *1	Complies with the requirements of the following directive and standards. Low Voltage Directive 2014/35/EU*2 EN 61010-1 (Class I*5, Pollution Degree 2*6)			

*1 Does not apply to specially ordered or modified PLZ-5Ws. *2 Limited to products that have the CE mark on their panels. *3 This is a Class A equipment. This product is intended for use in an industrial environment. This product may cause interference if used in residential areas. Such use must be avoided unless the user takes special measures to reduce electromagnetic emissions to prevent interference to the reception of radio and television broadcasts. *4 This is a Group 1 equipment. This product does not generate and/or use intentionally radio-frequency energy, in the form of electromagnetic radiation, inductive and/or capacitive coupling, for the treatment of material or inspection/analysis purpose. *5 This is a Class I equipment. Be sure to ground this product's protective conductor terminal. The safety of this product is only guaranteed when the product is properly grounded. *6 Pollution is addition of foreign matter (solid, liquid or gaseous) that may produce a reduction of dielectric strength or surface resistivity. Pollution Degree 2 assumes that only non-conductive pollution will occur except for an occasional temporary conductivity caused by condensation.

■ PLZ2405WB Specifications

Ratings		
Item	PLZ2405WB	
Operating voltage	1 Vdc to 150 Vdc	
Current	480 A	
Power	2400 W	
Current range		
H range	0 A to 480 A	
M range	0 A to 48 A	
L range	0 A to 4.8 A	
Setting accuracy		
CC mode	H range	± (0.4% of set + 0.8% of range)
	M range	± (0.4% of set + 0.8% of range)
	L range	± (0.4% of set + 5% of range)
CR mode	H range	± (0.5% of set + 1.5% of range)
	M range	± (0.5% of set + 1.5% of range)
	L range	± (0.5% of set + 5% of range)
CV mode	H,M,L range	± (0.2% of set + 0.2% of range)
CP mode	H range	± (2% of range + 0.4% current range × Vin ^{*1})
	M range	± (2% of range + 0.4% current range × Vin ^{*1})
	L range	± (2% of range + 2.5% current range × Vin ^{*1})
Measurement accuracy		
Voltmeter accuracy		± (0.1% of reading + 0.1% of range)
Ammeter accuracy	H range	± (0.4% of reading + 0.8% of range)
	M range	± (0.4% of reading + 0.8% of range)
	L range	± (0.4% of reading + 5% of range)
Protection functions		
Over temperature protection (OTP)	Turns off the load when the heatsink temperature reaches 100 °C	

*1 Vin: Load input terminal voltage or sensing terminal voltage.

General specifications		
Item	PLZ2405WB	
Input power supply voltage range	100 Vac to 240 Vac (90 Vac to 250 Vac) single-phase, continuous	
Input frequency range	47 Hz to 63 Hz	
Power consumption	95 VAm _{ax}	
Inrush current (peak value)	45 Apeak	
Operating temperature range	0 °C to 40 °C (32 °F to 104 °F)	
Operating humidity range	20%rh to 85%rh (no condensation)	
Storage temperature range	-20 °C to 70 °C (-4 °F to 158 °F)	
Storage humidity range	90%rh or less (no condensation)	
Installation location	Indoor use, altitude of up to 2000 m, overvoltage category II	
Isolation voltage	±500 V	
Insulation resistance	Between primary and input terminals	500 Vdc 30 MΩ or greater (at 70%rh humidity or less)
	Between primary and chassis	
	Between input terminals and chassis	
Withstanding voltage	Between primary and input terminals	No abnormalities at 1500 Vac for 1 minute
	Between primary and chassis	No abnormalities at 1500 Vac for 1 minute
	Between input terminals and chassis	No abnormalities at 750 Vdc for 1 minute
External dimensions	430(16.93)W×86(3.39)H×450(17.72)Dmm(inches)	
Weight	Approx. 15 kg (33.07 lb)	
Accessories	Power cord, Load input terminal cover, Parallel operation signal cable kit (PC01-PLZ-5W), Load input terminal screw set (2 sets), Screws for the load input terminal cover (2 pcs.), Operation manual	

Outline drawing

● PLZ205W, PLZ405W

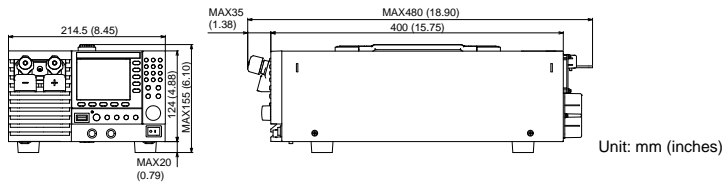

● PLZ1205W

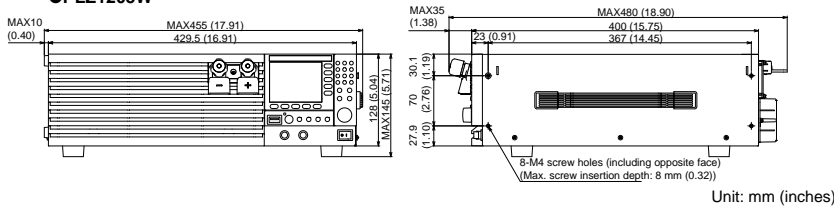

● PLZ2405WB

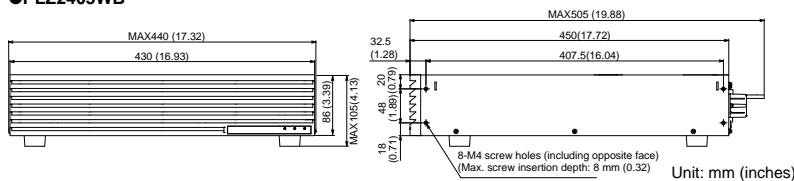

KIKUSUI ELECTRONICS CORPORATION

1-1-3, Higashiyamata, Tsuzuki-ku, Yokohama, 224-0023, Japan
Phone: (+81) 45-593-7570, Facsimile: (+81) 45-593-7571, www.kikusui.co.jp

KIKUSUI AMERICA, INC. 1-877-876-2807 www.kikusuiamerica.com

2975 Bowers Avenue, Suite 307, Santa Clara, CA 95051
Phone: 408-980-9433 Facsimile: 408-980-9409

KIKUSUI TRADING (SHANGHAI) Co., Ltd. www.kikusui.cn

Room308, Building 2, No.641, Tianshan Road, Shanghai City, China
Phone: 021-5887-9067 Facsimile: 021-5887-9069

For our local sales distributors and representatives, please refer to "sales network" of our website.

● Distributor:

■ All products contained in this catalogue are equipment and devices that are premised on use under the supervision of qualified personnel, and are not designed or produced for home-use or use by general consumers. ■ Specifications, design and so forth are subject to change without prior notice to improve the quality. ■ Product names and prices are subject to change and production may be discontinued when necessary. ■ Product names, company names and brand names contained in this catalogue represent the respective registered trade name or trade mark. ■ Colors, textures and so forth of photographs shown in this catalogue may differ from actual products due to a limited fidelity in printing. ■ Although every effort has been made to provide the information as accurate as possible for this catalogue, certain details have unavoidably been omitted due to limitations in space. ■ If you find any misprints or errors in this catalogue, it would be appreciated if you would inform us. ■ Please contact our distributors to confirm specifications, price, accessories or anything that may be unclear when placing an order or concluding a purchasing agreement.